

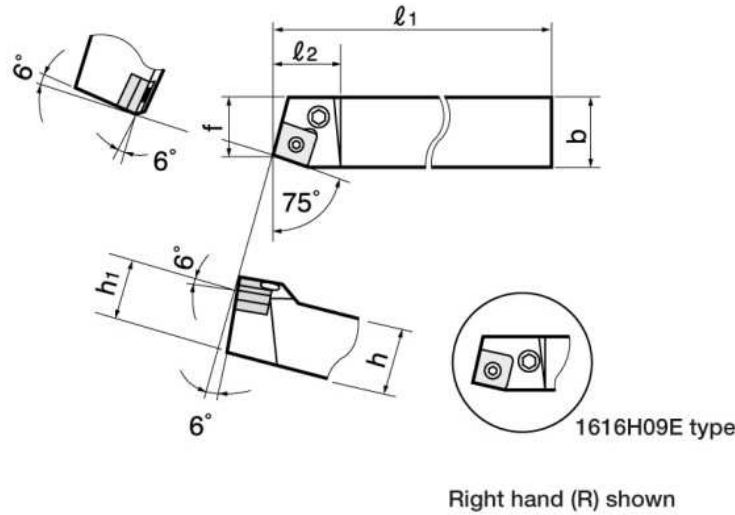

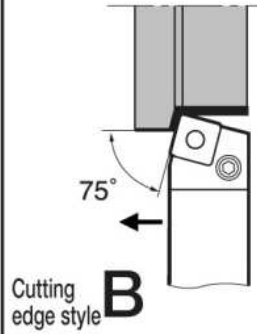





Turning

PSBN R/L







● Basic-choice chipbreaker

Appl.	Precision finishing	Finishing	Medium cutting	Roughing
Type	TF	TS	TM	TH
Shape	 (12)	 (12)	 (09, 12)	 (12, 15, 19)

Appl.	Heavy cutting	Medium cutting	Medium cutting	Precision finishing
Type	TU	SM	CM	PCBN/PCD
Shape	 (19, 25)	 (12)	 (12)	 (12)

For details see pp. 61 - 67

Cat. No.	Stock		Insert	Std. Corner R	Dimensions (mm)							Shim	Spring pin	Lever	Clamping screw	Wrench
	R	L			h	b	l ₁	l ₂	h ₁	f	f ₁					
PSBNR/L1616H09E			SN□□0903□□	0.8	16	16	100	22	16	13	—	ELSS32	LSP3L	LCL33	LCS3	P-2.5
PSBNR/L2020K12E	●	●	SN□□1204□□		20	20	125	28	20	17	—	ELSS42	LSP4S	LCL43M	LCS4	P-3
PSBNR/L2525M12E	●	●			25	25	150	24	25	22	—					
PSBNR/L3225P12E	●	●		32	25	170	28	32	22	—						
PSBNR/L2525M15E	●	●	SN□□1506□□	1.2	25	25	150	35	25	22	—	ELSS53	LSP5	LCL5	LCS5CA	P-3
PSBNR/L3225P15E					32	25	170	35	32	22	—					
PSBNR/L3232P15E					32	32	170	35	32	27	—					
PSBNR/L3232P19E	●	●	SN□□1906□□		32	32	170	40	32	27	—	ELSS63	LSP6	LCL6	LCS6	P-4
PSBNR/L4040R19E					40	40	200	40	40	35	—					
PSBNR/L5050T25E			SN□□2507□□	2.4	50	50	300	48	50	43	—	ELSS84	LSP8	LCL8	LCS8	P-5