

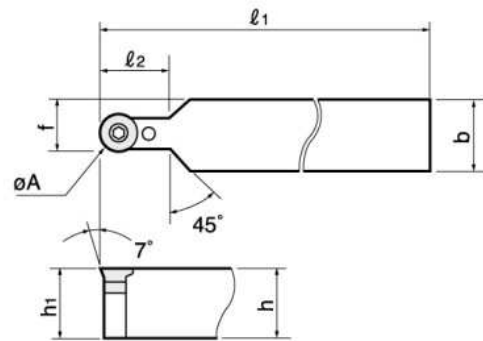

Profiling

PRDCN





Cutting edge style **D**



● **Basic-choice chipbreaker**

Appl.	Heavy cutting			
Type	61			
Shape	 (10, 12, 16, 20, 25)			

For details see p. 122

Cat. No.	Stock	Insert	Std. Corner R	Dimensions (mm)							Shim	Spring pin	Lever	Clamping screw	Wrench
				h	b	l ₁	l ₂	h ₁	f	f ₁					
PRDCN2020K10E PRDCN2525M10E	● ●	RCMM1003M0-61	-	20	20	125	22	20	15.0	10	ELSR32C	LSP3L	LCL3C	ELCS2	P-2
				25	25	150	22	25	17.5	10					
PRDCN2525M12E PRDCN3225P12E	●	RCMM1204M0-61		25	25	150	24	25	18.5	12	ELSR42C	LSP3	LCL4C	LCS3	P-2.5
				32	25	170	24	32	18.5	12					
PRDCN3225P16E	●	RCMM1606M0-61		32	25	170	28	32	20.5	16	ELSR53C	LSP4	LCL5C	ELCS3	P-2.5
PRDCN3232P20E	●	RCMM2006M0-61		32	32	170	32	32	26.0	20	ELSR63C	LSP6C	LCL6C	LCS5	P-3
PRDCN4040R25E		RCMM2507M0-61	40	40	200	42	40	32.5	25	ELSR84C	LSP6	LCL8C	LCS8C	P-4	