

Profiling

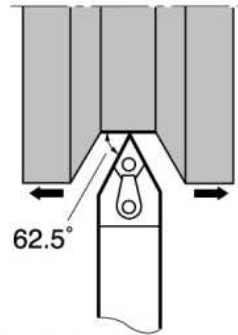

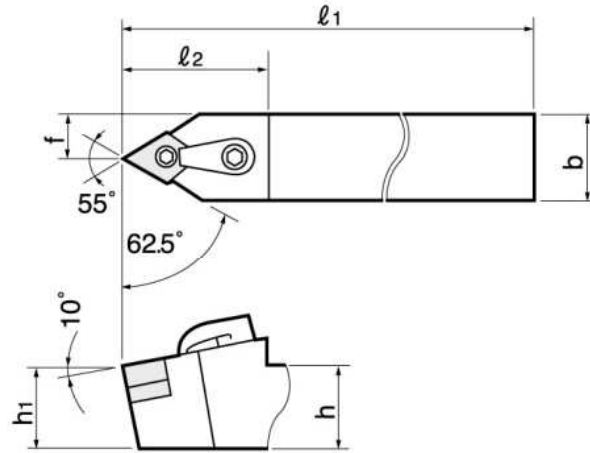





MDPNN



Cutting edge style **P**



● Basic-choice chipbreaker

Appl.	Precision finishing	Finishing	Medium cutting	Roughing
Type	TF	TS	TM	TH
Shape	 (1504)	 (1504, 06)	 (11, 1504, 06)	 (1504, 06)
Appl.	Medium cutting	Medium cutting		Precision finishing
Type	SM	CM	Ceramics	PCBN/PCD
Shape	 (1504, 06)	 (1504, 06)	 (1504)	 (1504, 06)

For details see pp. 52 - 59

Cat. No.	Stock	Insert	Std. Corner R	Dimensions (mm)							Shim	Lock pin	Shim screw	Clamp	Clamping screw	Breaker piece	Lock pin wrench	Wrench
				h	b	l1	l2	h1	f	f1								
MDPNN1616H11	△	DN□□1104□□		16	16	100	35	16	8	—	MSD-322	MLP34L	—	MCPM-20	MCS620-3	—	P-2F	P-3
MDPNN2020K15	●			20	20	125	45	20	10	—								
MDPNN2525M15	●	DN□□1506□□	0.8	25	25	150	45	25	125	—	MSD-432 (MSD-442)	MLP46L	— (MSP-6.3)	MCPM-22	MCS625-3	— (CBD-4MN)	P-2.5F	P-3
MDPNN3225P15	●	(DN□□1504□□)		32	25	170	45	32	125	—								
MDPNN3232P15	△			32	32	170	45	32	16	—								

Note : Parts in parenthesis are optional parts. For part assembly see p. 157.