

Facing

PTFN R/L

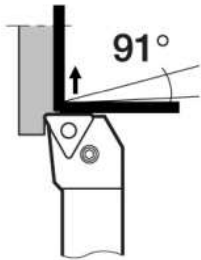

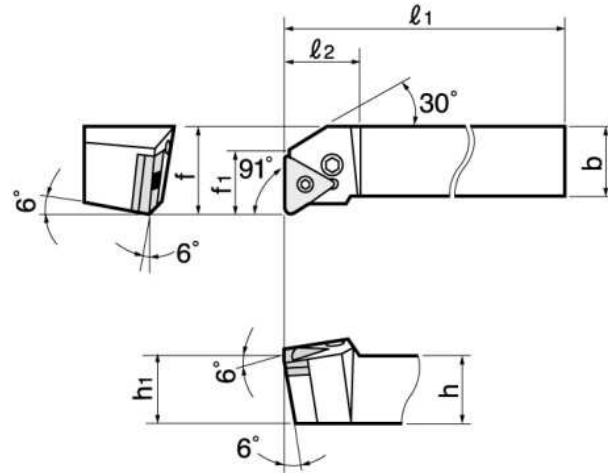







Cutting edge style **F**







Right hand (R) shown

● Basic-choice chipbreaker

Appl.	Precision finishing	Finishing	Medium cutting	Roughing
Type	TF	TS	TM	TH
Shape	 (16)	 (16)	 (16, 22)	 (22)

Appl.	Heavy cutting	Medium cutting	Medium cutting	Precision finishing
Type	57	SM	CM	PCBN/PCD
Shape	 (16, 22)	 (16)	 (16, 22)	 (16)

For details see pp. 70 - 76

Cat. No.	Stock		Insert	Std. Corner R	Dimensions (mm)						Shim	Spring pin	Lever	Clamping screw	Wrench	
	R	L			h	b	l ₁	l ₂	h ₁	f	f ₁					
PTFNR/L1616H16E	●	●	TN□□1604□□	0.8	16	16	100	22	16	20	18	ELST317	LSP3	LCL33	LCS3	P-2.5
PTFNR/L2020K16E	●	●			20	20	125	22	20	25	17.5					
PTFNR/L2525M16E	●	●			25	25	150	22	25	32	20					
PTFNR/L3225P16E	●	●			32	25	170	22	32	32	20					
PTFNR/L2525M22E	●	●	TN□□2204□□	0.8	25	25	150	28	25	32	24	ELST42	LSP4S	LCL43M	LCS3	P-3
PTFNR/L3225P22E	●	●			32	25	170	28	32	32	24					
PTFNR/L3232P27E			TN□□2706□□	1.2	32	32	170	31	32	40	30	LST53	LSP5	LCL5	LCS5	P-3
PTFNR/L4040P27E					40	40	200	31	40	50	30					