

Profiling

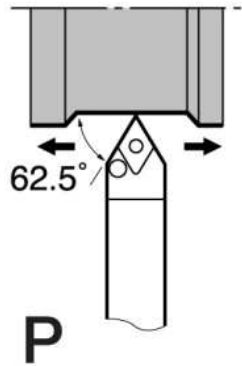

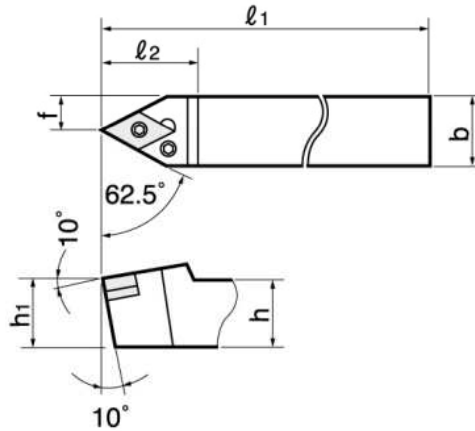



PDPNN







Cutting edge style



● Basic-choice chipbreaker

Appl.	Precision finishing	Finishing	Medium cutting	Roughing
Type	TF	TS	TM	TH
Shape	 (1506)	 (1506)	 (1506)	 (1506)
Appl.	Medium cutting	Medium cutting	Precision finishing	
Type	SM	CM	PCBN/PCD	
Shape	 (1506)	 (1506)	 (1506)	

For details see pp. 52 - 59

Cat. No.	Stock	Insert	Std. Corner R	Dimensions (mm)							Shim	Spring pin	Lever	Clamping screw	Wrench
				h	b	l ₁	l ₂	h ₁	f	f ₁					
PDPNN2525M15E	●	DN□□1506□□	1.2	25	25	150	36	25	12.5	—	ELSD42	LSP4S	LCL44	ELCS4	P-3
PDPNN3225P15E	●			32	25	170	36	32	12.5	—					