

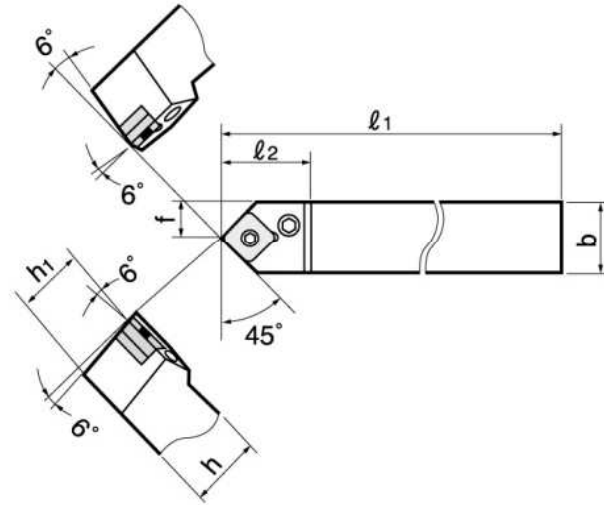

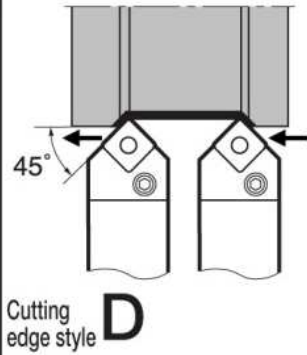





Turning • Chamfering

PSDNN







● Basic-choice chipbreaker

| Appl. | Precision finishing | Finishing | Medium cutting | Roughing |
|-------|---|---|---|---|
| Type | TF | TS | TM | TH |
| Shape |  (12) |  (12) |  (09, 12) |  (12, 15) |

| Appl. | Heavy cutting | Medium cutting | Medium cutting | Precision finishing |
|-------|---|---|---|---|
| Type | 65 | SM | CM | PCBN/PCD |
| Shape |  (12) |  (12) |  (12) |  (12) |

For details see pp. 61 - 67

| Cat. No. | Stock | Insert | Std. Corner R | Dimensions (mm) | | | | | | Shim | Spring pin | Lever | Clamping screw | Wrench | |
|---------------|-------|------------|---------------|-----------------|-----|----------------|----------------|----------------|------|----------------|---|---|---|---|---|
| | | | | h | b | l ₁ | l ₂ | h ₁ | f | f ₁ |  |  |  |  |  |
| PSDNN1616H09E | | SN□□0903□□ | 0.8 | 16 | 16 | 100 | 22 | 16 | 8.0 | — | ELSS32 | LSP3L | LCL33 | LCS3 | P-2.5 |
| PSDNN2020K12E | ● | SN□□1204□□ | | 20 | 20 | 125 | 30 | 20 | 10.3 | — | ELSS42 | LSP4S | LCL43M | LCS4 | P-3 |
| PSDNN2525M12E | ● | | | 25 | 25 | 150 | 30 | 25 | 12.8 | — | | | | | |
| PSDNN3225P12E | ● | | 32 | 25 | 170 | 30 | 32 | 12.8 | — | | | | | | |
| PSDNN3232P15E | | SN□□1506□□ | 1.2 | 32 | 32 | 170 | — | 32 | — | — | ELSS53 | LSP5 | LCL5 | LCS5CA | P-3 |