

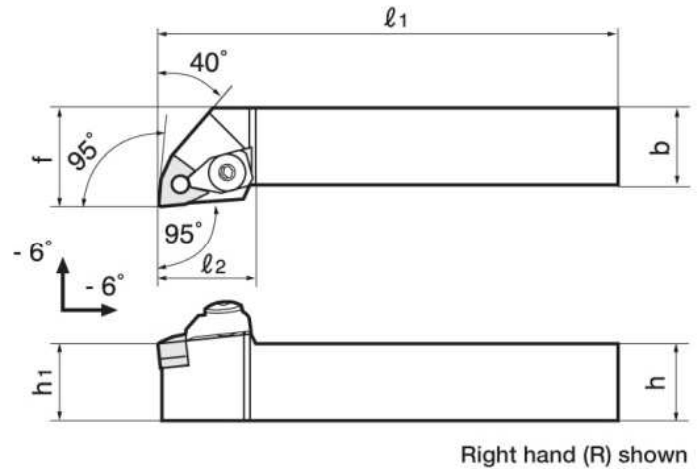

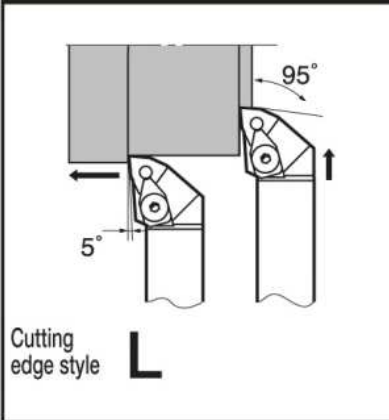





Turning•Facing









DWLN R/L



● Basic-choice chipbreaker

Appl.	Precision finishing	Finishing	Medium cutting	Roughing
Type	TF	TS	TM	TH
Shape	 (08)	 (08)	 (06, 08)	 (08)
Appl.	Medium cutting	Medium cutting	Medium cutting	Precision finishing
Type	SM	CM	All-round	PCBN/PCD
Shape	 (06, 08)	 (08)	 (06, 08)	 (08)

For details see pp. 78 - 82

Cat. No.	Stock		Insert	Std. Corner R	Dimensions (mm)							Shim	Spring pin	Lever	Clamp	Clamping screw	Piston	Spring	Wrench
	R	L			h	b	l1	l2	h1	f	f1								
DWLN R/L2020K06	●	●	WN□□0604□□		20	20	125	25.5	20	25	-	LSW312	LSP3	LCL33	DCPM-33	DLCS-33	DPIS33	BP-9	P-2.5
DWLN R/L2525M06	●	●			25	25	150	31	25	32	-								P-3
DWLN R/L2020K08	●	●	WN□□0804□□ -57 type chipbreaker cannot be used	0.8	20	20	125	31	20	25	-	LSW42	LSP4	DLCL43	DCPM-43	DLCS43	DPIS43	BP-10	P-3
DWLN R/L2525M08	●	●			25	25	150	31	25	32	-								P-4
DWLN R/L3225P08	●	●			32	25	170	30	32	32	-								