

Turning

PCBN R/L

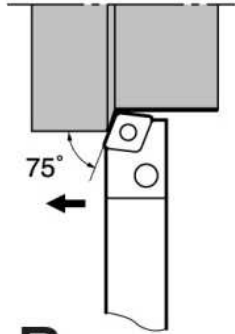

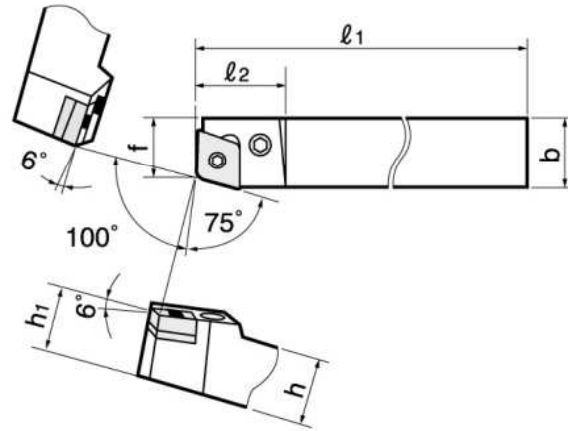





Cutting edge style **B**





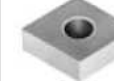

Right hand (R) shown

● Basic-choice chipbreaker

Appl.	Precision finishing	Finishing	Medium cutting	Roughing
Type	TF	TS	TM	TH
Shape	 (12)	 (12)	 (12)	 (12, 16, 19)

Appl.	Heavy cutting	Medium cutting	Medium cutting	Precision finishing
Type	TU	SM	CM	PCBN/PCD
Shape	 (12, 19)	 (12, 16, 19)	 (12, 16)	 (12)

For details see pp. 44 - 50

Cat. No.	Stock		Insert	Std. Corner R	Dimensions (mm)						Shim	Spring pin	Lever	Clamping screw	Wrench	
	R	L			h	b	l ₁	l ₂	h ₁	f	f ₁					
PCBNR/L2020K12E	●	●	CN□□1204□□	0.8	20	20	125	28	20	17	—	ELSC42	LSP4S	LCL43M	LCS4	P-3
PCBNR/L2525M12E	●	●			25	25	150	28	25	22	—					
PCBNR/L2525M16E	●		CN□□1606□□	1.2	25	25	150	35	25	22	—	ELSC53	LSP6C	LCL5	LCS5CA	P-3
PCBNR/L3225P16E					32	25	170	35	32	22	—					
PCBNR/L3232P16E					32	32	170	35	32	27	—					
PCBNR/L3232P19E	●		CN□□1906□□		32	32	170	40	32	27	—	ELSC63	LSP6	LCL6	LCS6	P-4